

PRODUCT INFORMATION

- Self-adhesive(with 3M glue)
- Flat-round, square, round style are available for selection.
- Rubber is black.
- PU is clear.
- Designed to meet with RoHS compliance.

Item Number	Material	Description	External Dimension(mm)
RF-1001	Rubber	ROUND HEMISPHERE STYLE	H:3.0mm D:6.0mm
RF-1002	Rubber	FLAT-ROUND STYLE	H:3.0mm D:11.5mm
RF-1004	Rubber	ROUND HEMISPHERE STYLE	H:5.0mm D:12.0mm
NEW RF-1006	Rubber	ROUND HEMISPHERE STYLE	H:2.5mm D:8.0mm
NEW RF-1014	Rubber	FLAT-ROUND STYLE	H:7.3mm D:20.0mm
RF-2006	Rubber	SQUARE STYLE	H:3.5mm W:13.0mm L:13.0mm
RF-2008	Rubber	ROUND STYLE	H:10.0mm D:22.0mm
RF-3001	Rubber	SQUARE STYLE	H:5.0mm W:10.0mm L:10.0mm
RF-3002	Rubber	SQUARE STYLE	H:5.7mm W:12.5mm L:12.5mm
RF-3004	Rubber	SQUARE STYLE	H:8.0mm W:20.0mm L:20.0mm
NEW RF-3006	Rubber	SQUARE STYLE	H:7.8mm D:20.5mm
RF-4010	Rubber	ROUND STYLE	H:10.0mm D:16.0mm

Rubber Feet

NEW
NEW

Item Number	Material	Description	External Dimension(mm)
RF-6002	PU	ROUND HEMISPHERE STYLE	H:2.5mm D:8.0mm
RF-6004	PU	ROUND STYLE	H:5.6mm D:10.3mm
RF-6006	PU	ROUND HEMISPHERE STYLE	H:6.0mm D:11.7mm
RF-6009	PU	SQUARE STYLE	H:5.4mm W:12.4mm L:12.4mm
RF-6010	PU	ROUND HEMISPHERE STYLE	H:2.7mm D:15mm
RF-6011	PU	ROUND HEMISPHERE STYLE	H:3.2mm D:20.5mm
RF-6012	PU	FLAT-ROUND STYLE	H:3.8mm D:12.5mm
RF-6016	PU	ROUND HEMISPHERE STYLE	H:8.0mm D:15.5mm

MATERIAL: RUBBER (SELF-ADHESIVE/WITH 3M GLUE) ; COLOR: BLACK

RF-1001

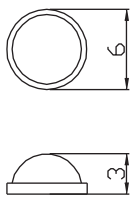

RF-1014

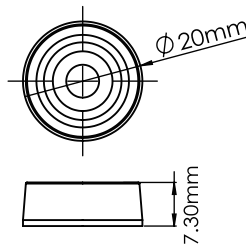

RF-3002

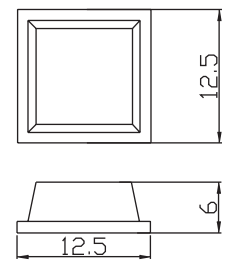

RF-1002

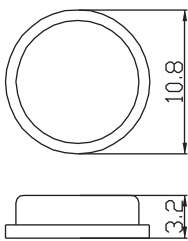

RF-2006

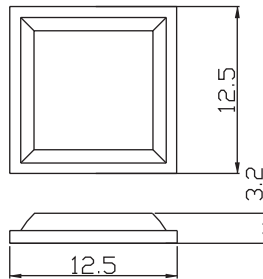

RF-3004

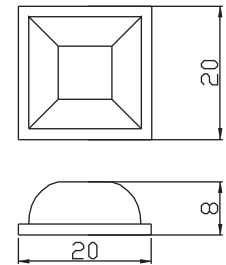

RF-1004

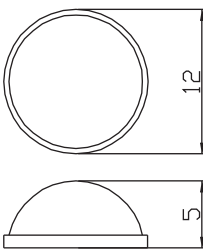

RF-2008

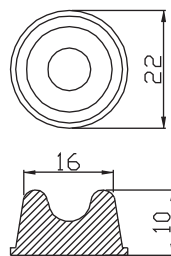

RF-3006

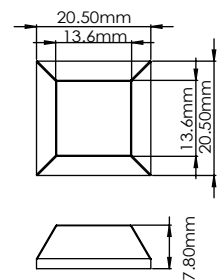

RF-1006

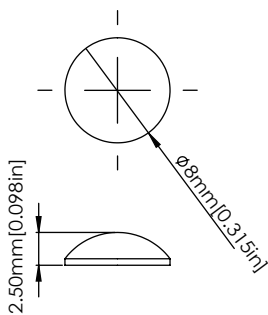

RF-3001

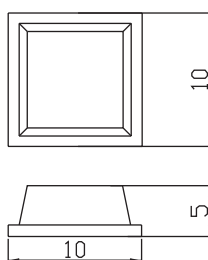

RF-4010

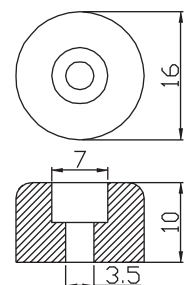

Rubber Feet

MATERIAL: PU (SELF-ADHESIVE/WITH 3M GLUE) ; COLOR: CLEAR

RF-6002

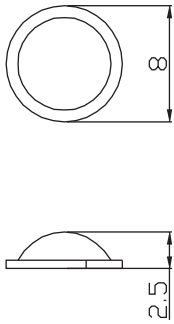

RF-6009

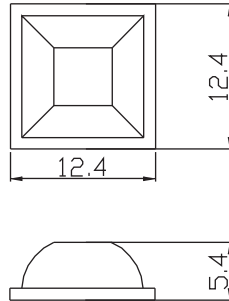

RF-6012

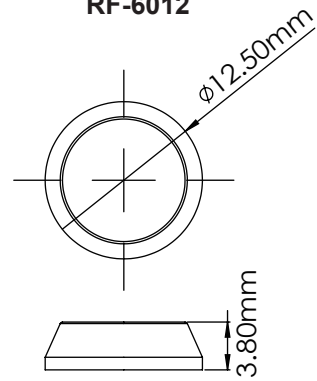

RF-6004

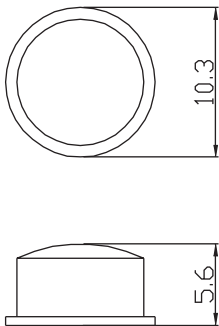

RF-6010

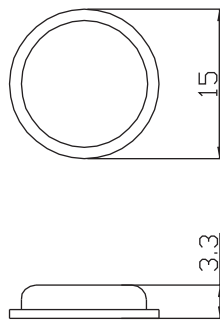

RF-6016

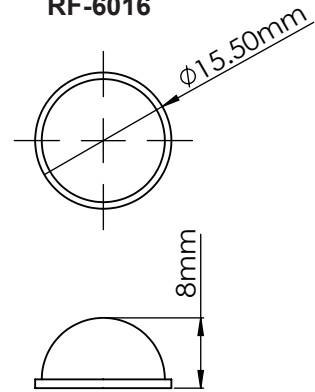

RF-6006

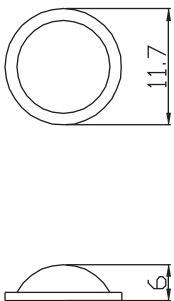

RF-6011

